

Model: OS-100 series

OS Indoor / Outdoor Speaker (100W)



Description

Lowell Models OS100TB (black) and OS100TW (white) are attractively styled, 100W two-way music speakers that provide excellent sound reproduction at 8-ohms, 25V, 70V or 100V. They are engineered for indoor or protected outdoor use in upscale retail, restaurant, commercial, professional, educational or residential applications. OS100T Series features an architecturally curved plastic housing with a weather resistant terminal cover, fine mesh grille and U-shaped mounting bracket. Both the grille and bracket are made of aluminum for long lasting quality appearance.

The two-way speaker features a 6.5" mica-coated woofer with a rubber surround for weather resistance. The high quality tweeter is a 1" silk domed driver for flat and smooth high frequency response. Power rating is 100 watts with a frequency response of 97Hz-20kHz ± 6dB and average sensitivity of 87.8dB measured 1W/1M. Each speaker measures 11.15"H x 8.66"W x 8.5"D (with bracket). The assembly weighs 7.35 pounds and is packaged one per box.

Connections are made using stranded wire up to 14 gauge to a removable 4-conductor Phoenix connector. The connector is protected by a weather-resistant terminal cover and rubber grommet which may be removed when larger wire sizes are used. The rear of the speaker features an 8-ohm / transformer selector switch. The switch is adjusted using a screwdriver to select 8-ohm (no transformer), 70V, 25V or 100V tap positions. (see page 4). The U-bracket is factory installed to the speaker with two (2) threaded screw handles and provides for 90° horizontal or vertical rotation. The bracket is equipped with slots for easy installation to a single gang E.O. Box. Note: To facilitate other types of brackets, the rear of the speaker housing includes 1/4" - 20 threaded mounting points (see page 4). Optional brackets that mount to the 1/4" - 20 mounting points include omni-directional bracket Model OS-BRKT-B (black) or Model OS-BRKT-W (white) - order separately from Lowell or OmniMount® Series 20.5 brackets - order from others.

Features

- Compact speaker assembly with 100W power rating meets specifications for high quality indoor and outdoor music applications.
- Features a 6.5" mica coated woofer with rubber surround and a 1" silk domed tweeter for accurate sound reproduction.
- Curved housing is molded plastic with a weather-resistant terminal cover and an attractive fine mesh aluminum grille.
- Selector switch allows for direct 8-ohm or distributed 70V, 25V or 100V distributed system operation.
- Adjustable U-bracket provides easy surface installation to a single gang E.O. box.
- OS Series will also accept other bracket styles including omni-directional bracket Series OS-BRKT (order separately from Lowell) or OmniMount® Series 20.5 (order from others).



The OS series indoor/outdoor speaker is available in black or white. Includes U-shaped mounting bracket.



Optional omni-directional bracket is also available in black or white.

A & E Specifications

The speaker for indoor / outdoor foreground music application shall be Lowell Model ____ (OS100TB, OS100TW). The speaker shall have a 6.5" mica coated woofer with a 1" silk domed tweeter. It shall have a 100W power rating with a screwdriver adjustable switch for direct 8-ohm 70V, 25V or 100V volt distributed application. It shall have a frequency response of 97Hz - 20kHz ± 6dB and a sensitivity of 87.8dB measured 1W/1M. The housing shall be molded plastic with a fine mesh aluminum grille finished in ____ (black, white) powder epoxy paint. The assembly shall include an adjustable U-bracket for vertical or horizontal installation and shall feature slots for mounting to a single gang E.O. box. The housing shall be equipped with 1/4" - 20 threaded inserts to accept other bracket styles including Lowell omni-directional Model OS-BRKT-B and OS-BRKT-W. Each speaker shall measure 10.83"H x 8.66"W x 6.62"D (without bracket), 11.15"H x 8.66"W x 8.5"D (with bracket) and weigh 7.3lbs.

Model No.	Description	Size	Color	Carton Wt. (lbs)
OS-100-TB	OS Indoor/Outdoor Speaker System	100W	Black	6
OS-100-TW	OS Indoor/Outdoor Speaker System	100W	White	6
OS-BRKT-B	Omni-directional Bracket		Black	2
OS-BRKT-W	Omni-directional Bracket		White	2

OS Indoor / Outdoor Speaker (100W)

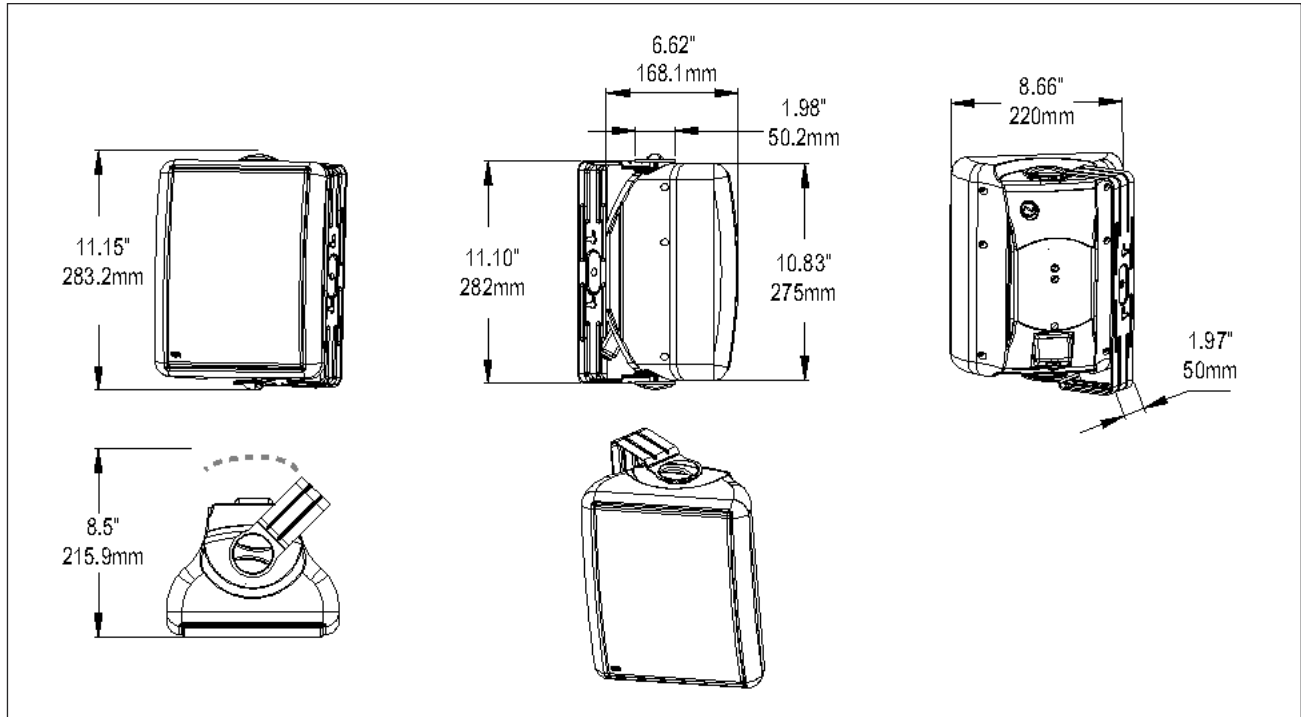

PERFORMANCE

Power Handling	100 watts RMS measured per EIA Standard RS-426B at 8ohms
Sensitivity	87.8dB SPL (avg) measured 1 Watt at 1 Meter 107.8dB SPL (max) calculated 100 Watts at 1 Meter
Frequency Response	97Hz - 20kHz (+6dB)
Impedance	8 ohms (nominal), 7.3 ohms @ 244Hz (minimum) Impedance readings expected from typical 1kHz impedance Meter: Switch setting A: 105 ohms Switch setting B: 210 ohms Switch setting C: 420 ohms Switch setting D: 840 ohms 8 ohm setting: 12.8 ohms
Dispersion	Horizontal (grille on): 135° conical @ 2000Hz octave (-6dB) Vertical (grille on): 105° conical @ 2000Hz octave (-6dB)

DRIVERS

Woofer	6.5" mica coated with rubber surround
Tweeter	1" silk domed

CABINET MECHANICAL

Cabinet Housing	Molded Plastic: OS100TW (White), OS100TB (Black)
Cabinet Grille	Fine mesh Aluminum painted white or black to match housing
U-Bracket	Aluminum painted white or black to match housing
Input Terminals	Phoenix type connector with weather protective boot. (14AWG stranded wire max.)
Dimensions (not including bracket)	10.83"H x 8.66"W x 6.62" D, (275mm x 220mm x 168.1mm)
Dimensions (including bracket)	11.15"H x 8.66"W x 8.5"D, (283.2mm x 220mm x 215.9mm)
Weight (each)	Net Weight: 7.35 lbs. (3.33kg), Shipping Weight: 8.60 lbs. (3.90kg)
Carton Qty	Packed in single cartons.

TRANSFORMER

Tap	25V line	70V line	100V line
A	7.5W	60W	Do not use
B	3.8W	30W	60W
C	1.9W	15W	30W
D	0.94W	7.5W	15W



Scope of performance and power tests

Lowell loudspeaker drivers and loudspeaker systems are thoroughly tested to provide specifiers and contractors with solid data that accurately reflects the performance of the production products. Performance tests are conducted on randomly selected final production assemblies. Testing equipment includes the GoldLine TEF-20 analyzer.

Power Handling capability is tested based on EIA Standard RS-426B.

Frequency Response data is provided which is the measured generally usable frequency response range (defined by $\pm 6\text{dB}$) that is useful in predictive engineering calculations.

Sensitivity (SPL) data is presented in two ways: Average SPL is a computer calculated log average of the SPL over the stated frequency response. Max SPL is based on the 1 watt 1 meter measured value of the SPL and the calculated max SPL at the maximum power rating of the driver.

Dispersion Angle is defined as the angle of coverage that is no more than 6dB down from the on-axis value averaged over the 2000Hz octave band.

Since speech intelligibility is very dependent upon the 2000Hz octave, this specification is quite useful in designing speech reinforcement systems that provide even coverage and speech intelligibility.

Impedance data is presented in three ways: Nominal Impedance is the generally accepted impedance for use in making comparisons with competitive products. The Impedance Curve is a graphical representation of the impedance that is measured in the lab and gives the impedance of the device over the audio frequency range. Minimum Impedance is the lowest impedance measurement at a frequency within the specified frequency response of the speaker. If a line matching transformer is included in the speaker assembly, relative impedance curves of the primary windings of the transformer when loaded by the driver may be shown.

Polar data is presented for both Horizontal and Vertical orientation of two-way speakers that incorporate separate low frequency and high frequency drivers. It depicts the averaged one octave band surrounding the center frequencies of 1000Hz, 2000Hz, 4000Hz, and 8000Hz. Radial polar response curves show the relative change in sound pressure level as one moves from directly on-axis to an increasingly off-axis listening position.

SPL vs. Frequency 1W / 1M

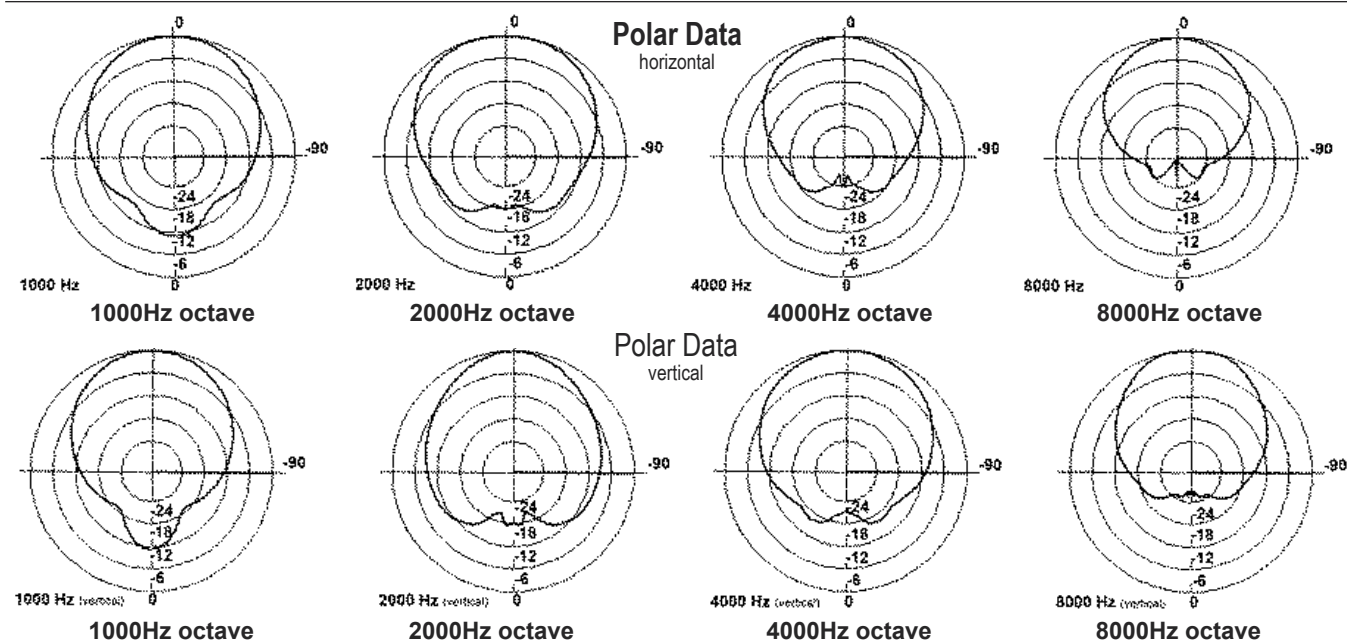
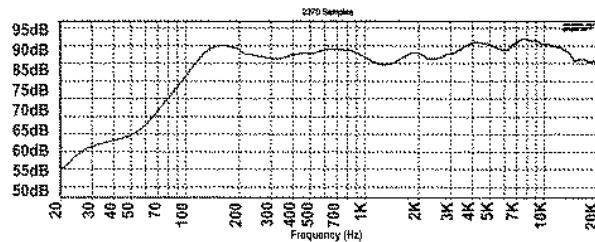

Impedance - 8ohm

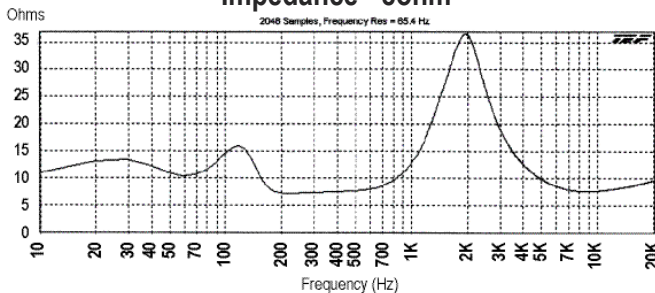

Impedance - Switch settings A - D

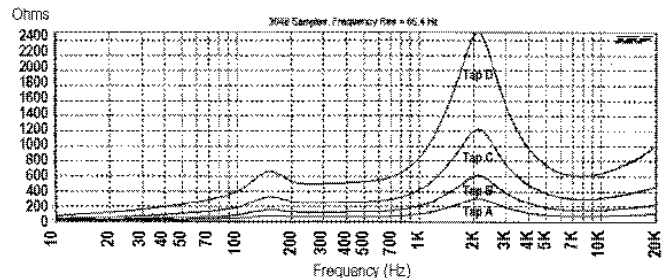

Mounting Methods

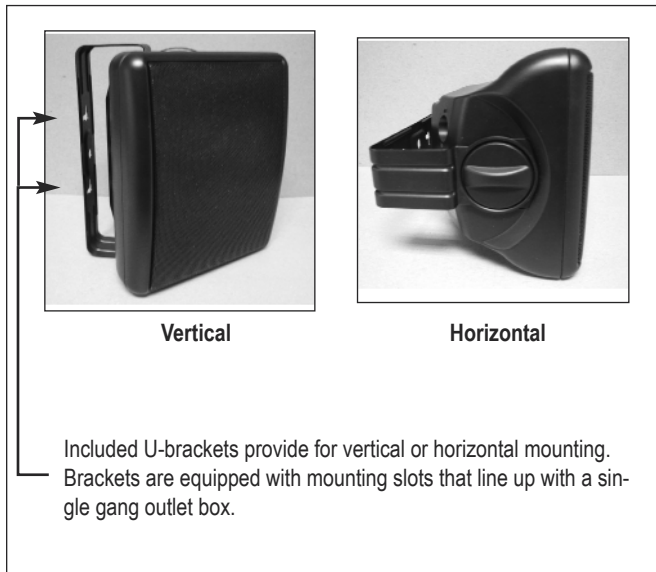

Installation using supplied U-brackets

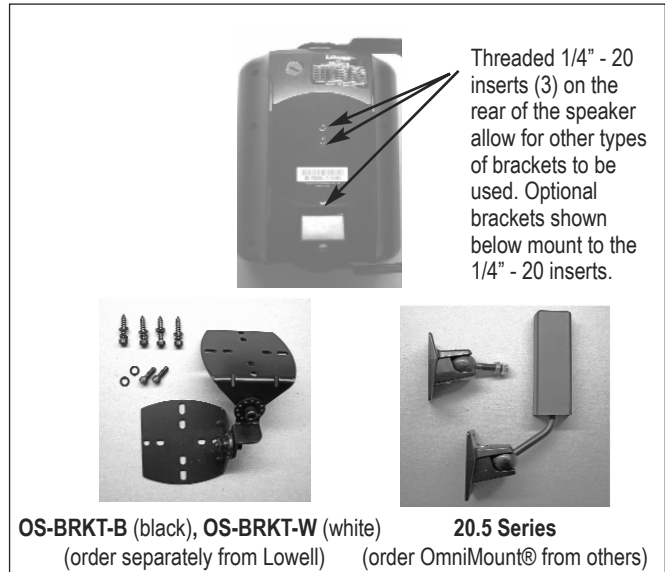

Installation using optional brackets

Bracket	Description	Manufacturer
OS-BRKT-B	omni-directional, black	Lowell
OS-BRKT-W	omni-directional, white	Lowell
Series 20.5	omni-directional	OmniMount

Connections

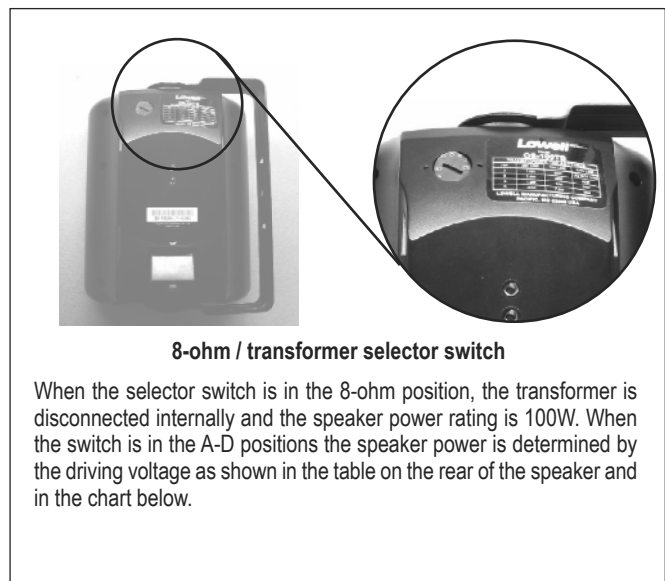

Tap	25V line	70V line	100V line
A	7.5W	60W	Do not use
B	3.8W	30W	60W
C	1.9W	15W	30W
D	0.94W	7.5W	15W

