



Facilement ajustable Support Vertical Pour Moniteur

Conçu pour vous!



Support Vertical Pour Moniteur Double

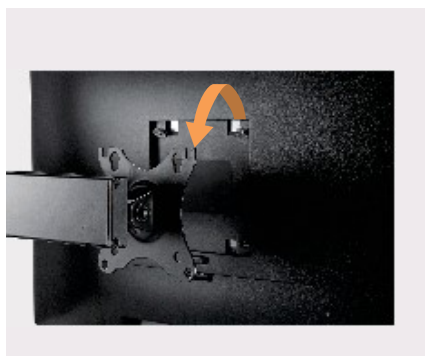
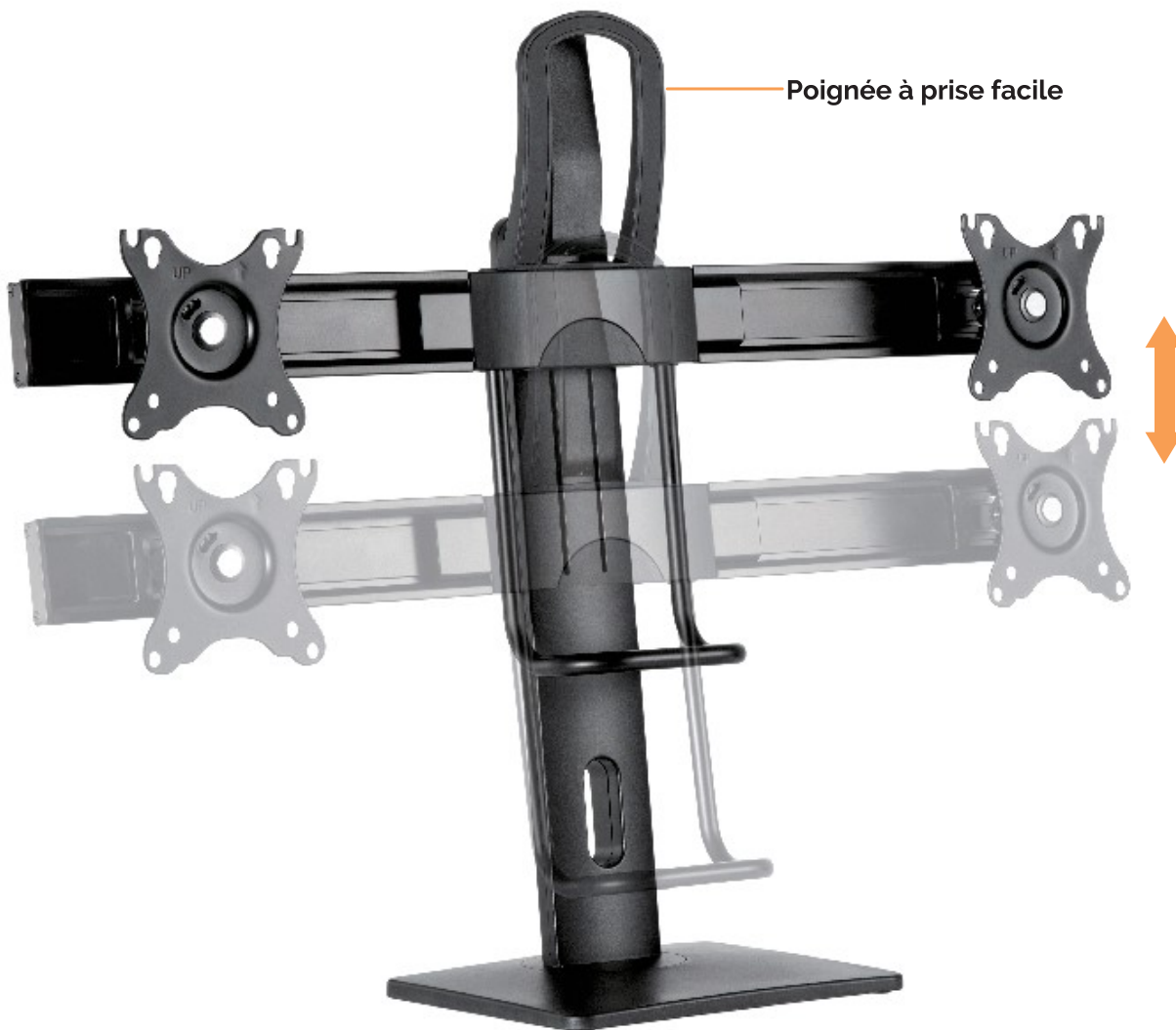

**Système d'encrage
Pour une installation facile**

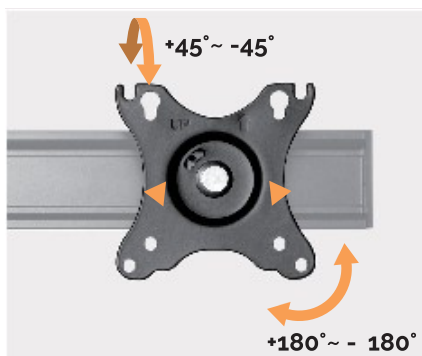









**Réglage multiples
Pour une position optimal**









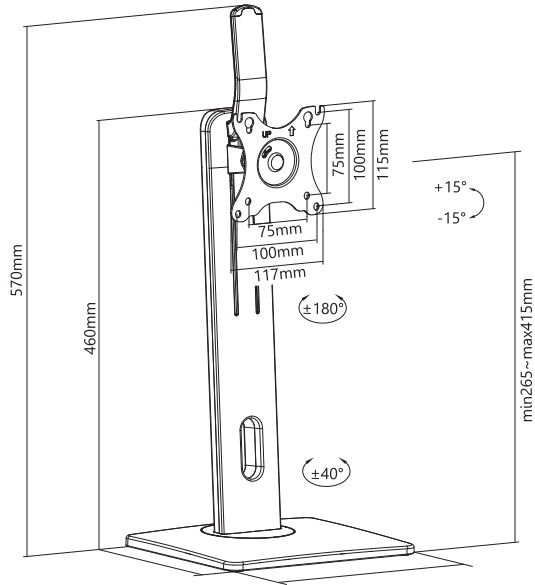

**Base rotative $+40^{\circ} \sim -40^{\circ}$
pour un partage facile**

MS401

-  **Taille des moniteurs**
17"-32"
-  **Compatible VESA**
75x75 100x100
-  **Capacité de poids (par écrans)**
2-7kg/4.4lbs-15.4lbs
-  **Ajustement de la Hauteur**
min265mm(10.4")-max415mm(16.3")
-  **Inclinaison**
+15° - -15°
-  **Pivotement**
+40° - -40°
-  **Moniteur incurvé**
-  **Rotation**
+180° - -180°
-  **Gestion des cables**

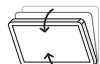

MS402

-  **Taille des moniteurs**
17"-27"
-  **Compatible VESA**
75x75 100x100
-  **Capacité de poids**
2-6kg/4.4-13.2lbs
-  **Ajustement de la Hauteur**
min245mm(9.6")-max400mm(15.7")
-  **Inclinaison**
+45° - -45°
-  **Pivotement**
+40° - -40°
-  **Moniteur incurvé**
-  **Rotation**
+180° - -180°
-  **Gestion des cables**

